

HRD30 Spare Parts List

HYCON Rock Drill

From Serial No.
19471-



Revised 01-03-2022

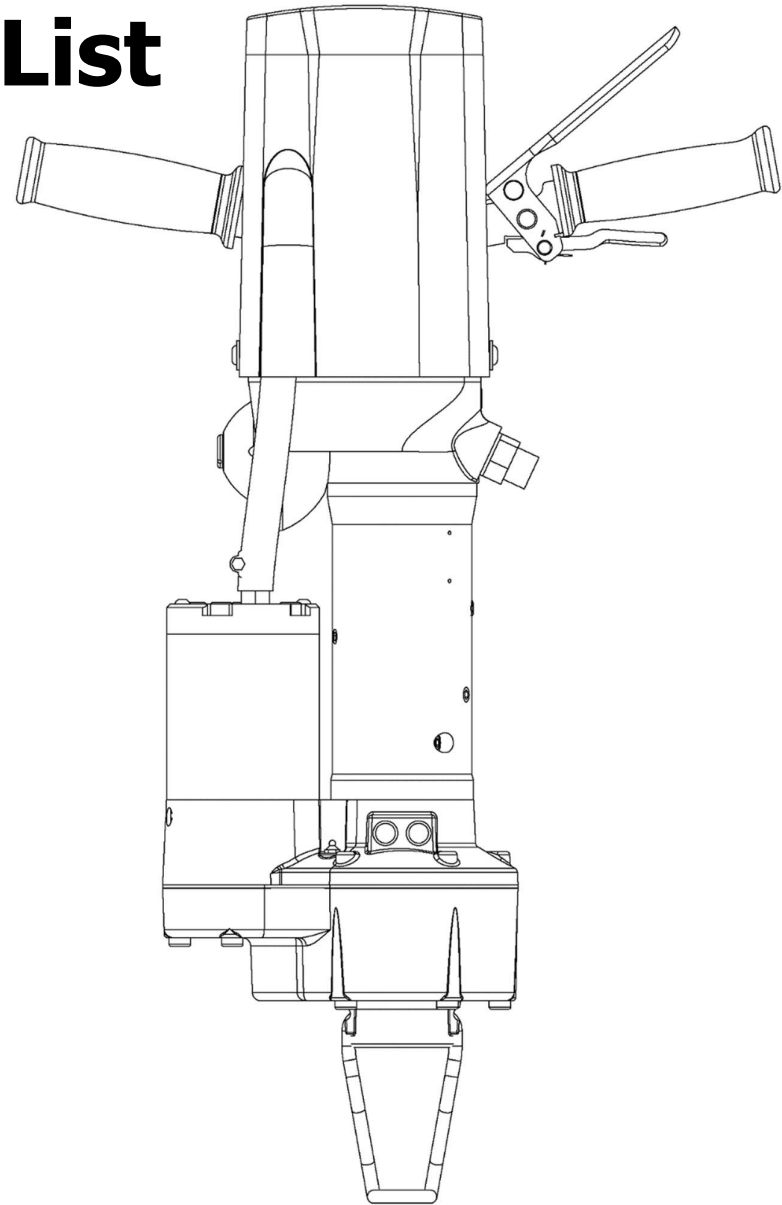

HRD30 parts list

Fig. 1

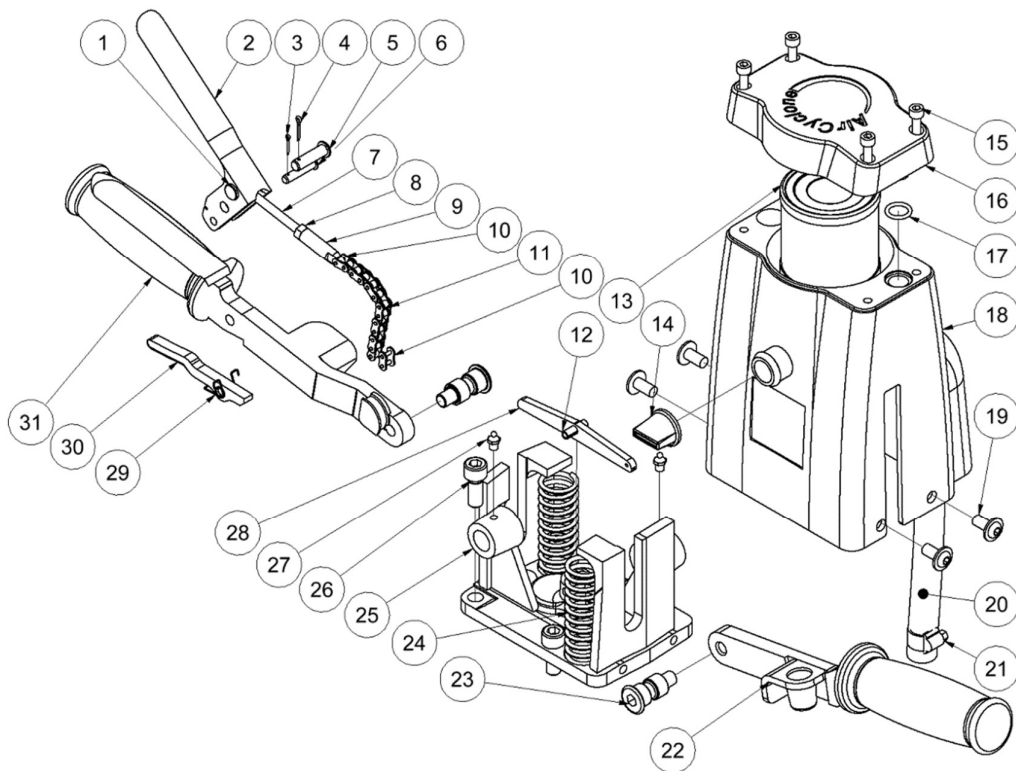

Pos.	Part No.	Description	Pcs.
1	8211271	Cross pin	1
2	8211270	Trigger lever	1
3	7612139	Split pin $\varnothing 1.6 \times 10$	1
4	7612138	Split pin $\varnothing 2.0 \times 12$	1
5	8612136	Pin $\varnothing 8 \times 27$	1
6	8612137	Pin $\varnothing 6 \times 27$	1
7	7611277	Screw M6x80 <i>Loctite 243</i>	1
8	7611278	Nut M6	1
9	8211279	Adaptor	1
10	7611280	Joint	2
11	9011662	Chain	1
12	7611284	Roll pin 6x20	1
13	7613240	Airfilter	1
14	7713248	Dirt valve	1
15	7622067	Screw M6x30	4
16	8713239	Filter Lid	1
17	7532812	O-ring 14x2,5	1
18	8713501	Airfilter cover	1
19	7611282	Screw M8x16	4
20	7713243	Hose	1
21	7421081	Hose clamp	1
22	8711287	Handle	1
23	8211260	Shaft for handle <i>Loctite 243 - 80NM</i>	2
24	8611289	Compression spring	2
25	8213140	Housing	1
26	7611283	Screw M10x25 <i>Loctite 243 - 80NM</i>	4
27	7611285	Grease nipple M6	2
28	8211286	Boom	1
29	8611291	Spring	1
30	8211273	Safety trigger	1
31	8711275	Handle (trigger side)	1
-	9013500	Service kit (2 pcs Pos. 13 Air filter and 1pcs vane set)	-

HRD30 parts list Fig. 2

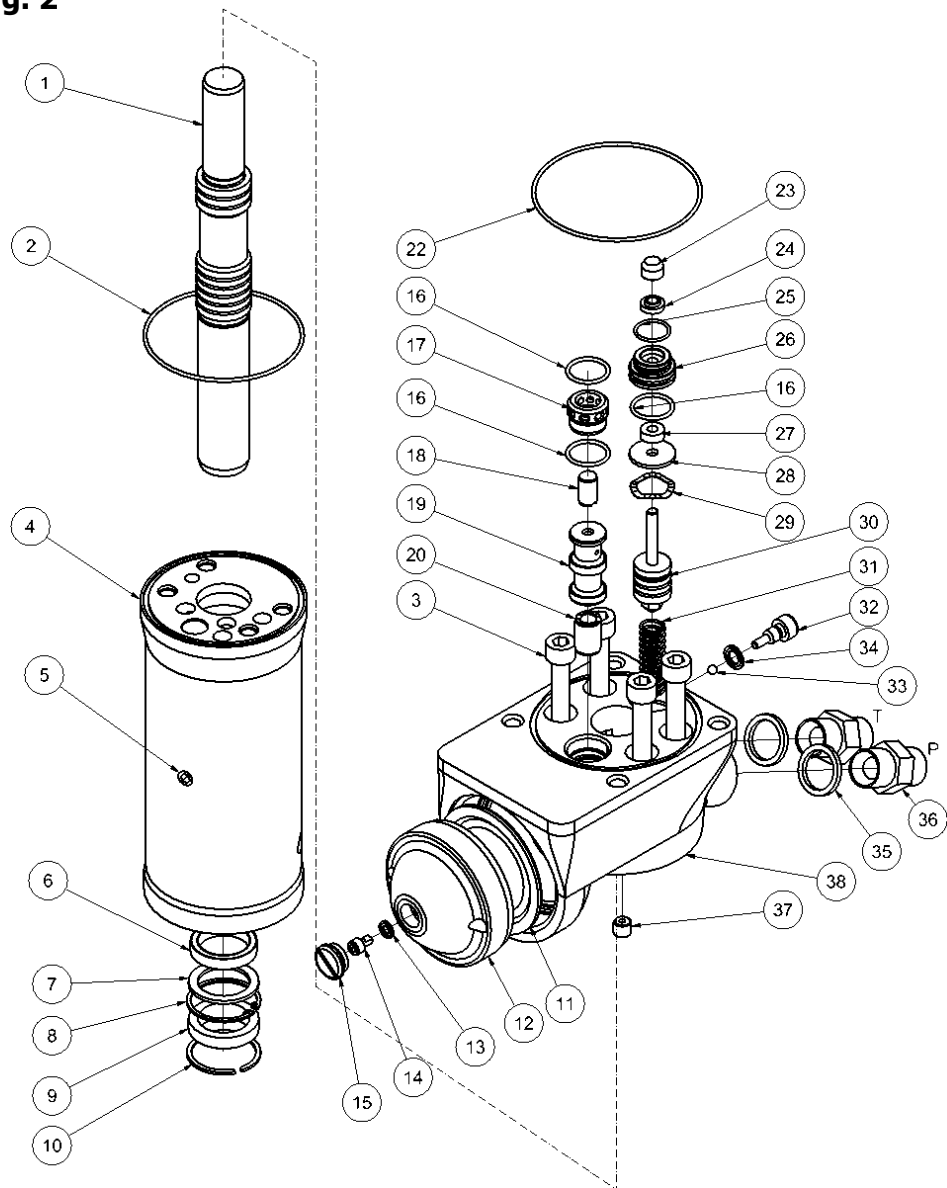

Pos.	Part No.	Description	Pcs.
-	4141358	1/2" tailhose-set 0.3 m	1
-	7401141	Q.R. coupling 1/2" BSP male	1
-	7401142	Q.R. coupling 1/2" BSP female	1
1	8213138	Striking piston	1
2	7511247	O-ring 82x2	1
3	7611244	Screw M10x75 <i>Tighten crosswise 20-40-80 Nm</i>	4
4	8213254	Cylinder	1
5	7621037	Pipe plug 1/8"	6
6	7511231	Seal ø28/ø36x5.7	1
7	8211257	Supporting washer 28.7x38x2.0	1
8	7611258	Retaining ring	1
9	7511233	Rod wiper	1
10	7611259	Spring ring	1
11	7711091	Diaphragm	1
12	8211216	Accumulator cover	1
13	7511268	Seal ring M5	1
14	8611269	Screw M5 f/accumulator	1
15	8211256	Plug	1
16	7511248	O-ring 20x2	2
17	8213136	Sleeve	1
18	8213134	Pilot Spool Small	1
19	8213133	Spool	1
20	8213135	Pilot Spool Big	1
22	7511246	O-ring 88x2	1
23	8211227	Distance piece	1
24	7521013	Wiper	1
25	7511300	O-ring 17x1.5	1
26	8211226	Seal housing	1
27	7521014	Seal	1
28	8211251	Washer	1
29	7611252	Crinkled spring washer 23.8x17.3x0.3	1
30	9011750	Trigger piston complete	1
31	8611249	Compression spring 1.25x12.5x62.5	1
32	8611255	Screw M8 f/lock nut	1
33	7611253	Ball ø5 mm	1
34	7511254	Seal ring M8	1
35	7521072	Seal ring 1/2"	2
36	7421063	Fitting 1/2"x1/2" BSP <i>Only for tail-hoses with female thread</i>	2
36	7421343	Fitting 1/2"x3/4" JIC <i>Only for tail-hoses with female thread</i>	2
37	8213139	Nozzle	1
38	8213132	Valve housing	1
-	9013208	Seal kit	1

HRD30 parts list
Fig. 3

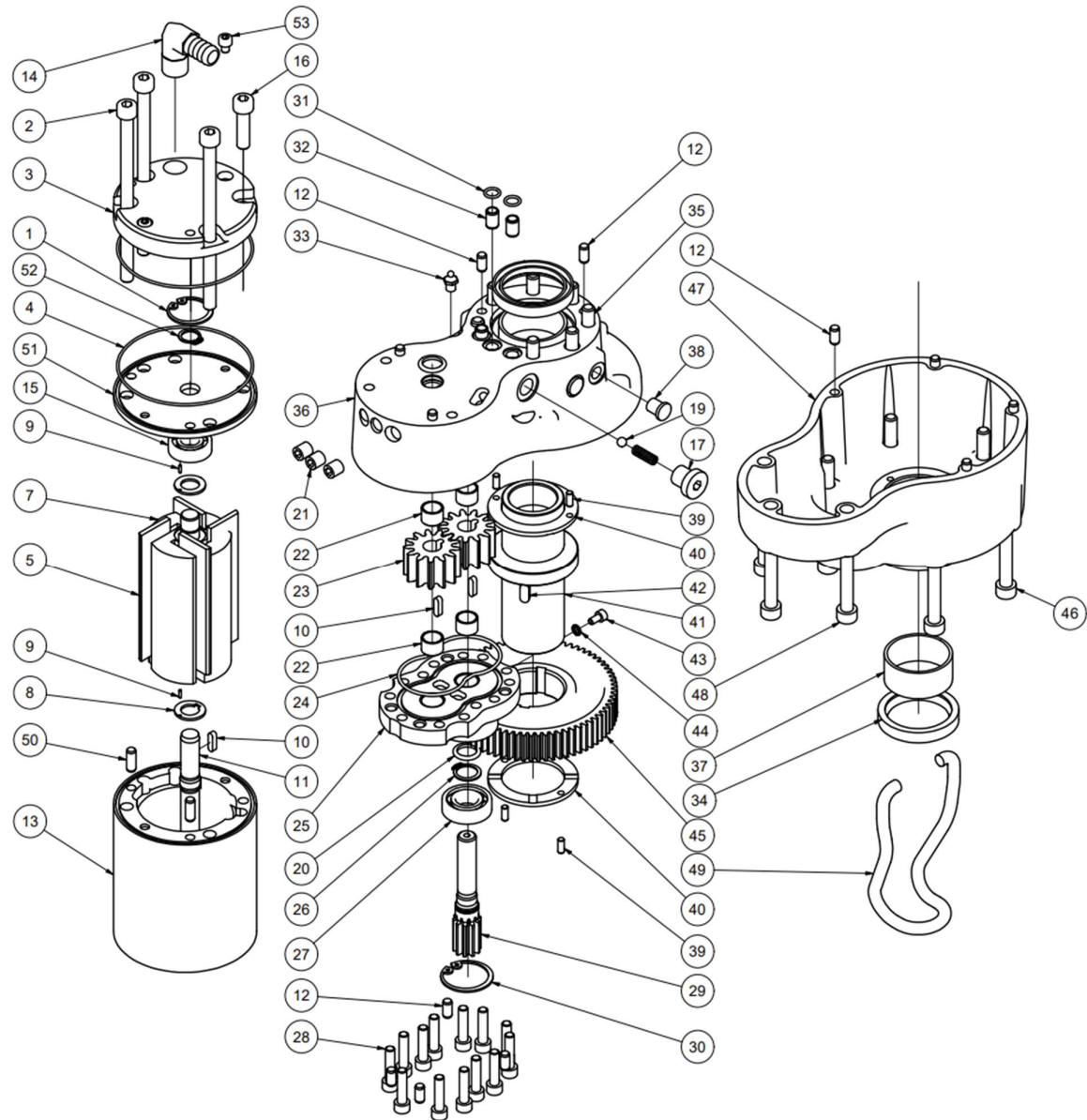

HRD30 parts list

Fig. 3

Pos.	Part No.	Description	Pcs.
1	7613190	Retaining ring	1
2	7613192	Screw M8x130 40 Nm	4
3	8213530	Lid f/ compressor	1
4	7513186	O-ring 85x1,5	3
5	9013230	Vane set (4 vanes pr set)	1
6	8213210	Thrust Washer	2
7	9013249	Rotor f/ compressor	1
8	8213247	Thrust Washer w/ key way	1
9	7613183	Cylinder pin Ø1,5x6	2
10	7632780	Key	2
11	8213244	Shaft f/ compressor	1
12	7631391	Cylinder pin ø6x12	12
13	8213250	Housing f/ compressor	1
14	7413255	Hose fitting Loctite 542	1
15	7613189	Ball Bearing	1
16	7621045	Screw M8x30 40 Nm	
17	8213171	Pipe plug 1/8"	1
18	8613175	Compression spring HRD	1
19	7613176	Ball ø6 mm	1
20	7532774	Seal	2
21	7621037	Pipe plug 1/8"	3
22	7632777	Bearing Ø12x10	4
23	8232801	Gear HRD	2
24	7532776	O-ring ø62x2	1
25	8213168	Cover f/motor rock drill	1
26	7632649	Retaining ring A15	1
27	7632538	Ball bearing	1
28	7611243	Screw M6x25 Loctite 243 - 7.5 Nm	13

Pos.	Part No.	Description	Pcs.
29	8213164	Gear HRD Small	1
30	7632995	Retaining ring	1
31	7532540	O-ring 8x1.5	3
32	8213174	Bushing HRD	3
33	7611285	Grease nipple straight	1
34	7513200	Seal ø40/ø52x8	2
35	7611574	Screw M8x60 Loctite 243 - 40 Nm	7
36	8213151	Nosepart HRD Upper	1
37	7613170	Plain Bearing HRD	2
38	7723046	Plug	4
39	7613194	Cylinder pin Ø4x10	4
40	8213169	Thrust Washer	2
41	8213163	Bushing HEX 22x108 HRD	1
42	7613172	Key	1
43	7613178	Screw M4x8	1
44	7513177	Seal ring M4	1
45	8213165	Gear HRD Large	1
46	7611572	Screw M8x80 Loctite 243 - 40 Nm	5
47	8213162	Nosepart HRD Lower	1
48	7613179	Screw M8x45 Loctite 243 - 40 Nm	3
49	8213193	Drill Latch	1
50	7632395	Cylinder pin ø6x16	2
51	8213529	Intermediate disk	1
52	7623531	Retaining ring 12x1	1
53	7623535	Screw M5x6	2
-	9013208	Seal kit	1
-	9013500	Service kit (1 pcs Pos. 7 Vane set and 2 pcs Air filter)	-