



Bobcat[®]

One Tough Animal.

COMPACT EXCAVATORS

E17, E17z, E19, E20z

0-1t | 1-2t | 2-3t | 3-4t | 4-6t | 6-10t

🌐 Europe

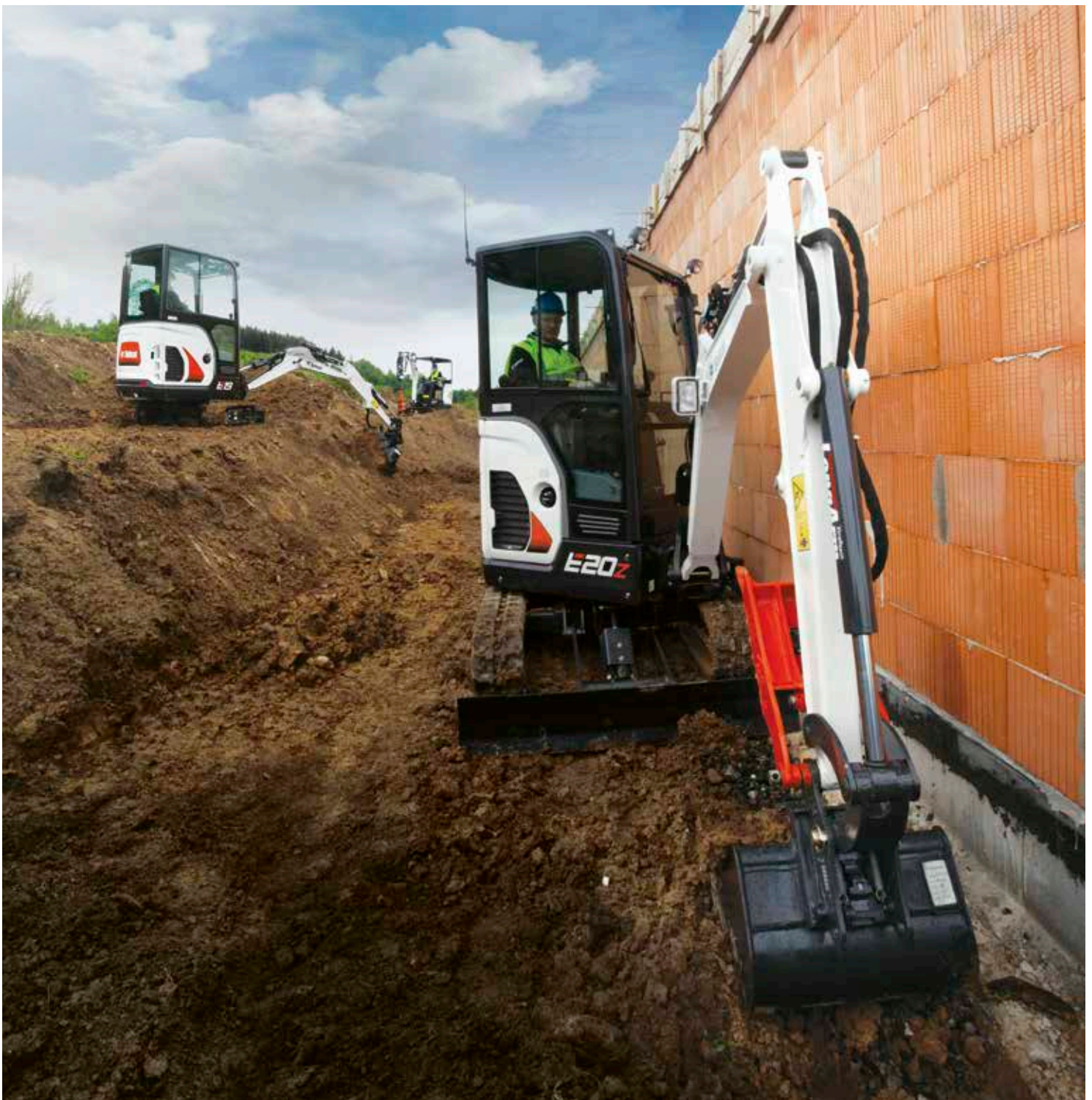

ONE TOUGH ANNUM

► **OUR MISSION**

We empower operators to accomplish more, while working in the toughest conditions and tightest situations. When our customers have the will, we provide the way.

INTRODUCTION



► BOBCAT'S HISTORY

In 1958, Melroe Manufacturing Company introduced a compact front-end loader that evolved quickly into the M400, the world's first true skid steer loader. The company soon adopted what became the world-famous 'Bobcat' brand – and its success paved the way for the global compact equipment industry we know today.

► INNOVATION CENTER IN DOBŘÍŠ

New technologies and machines are rigorously tested to take on the toughest jobs.



► BOBCAT TODAY

Since developing Mini Excavators with Zero House Swing functionality in 1984, Bobcat has continued to innovate. Today, our equipment is known for providing all the power you need, where you need it, without any hassle.



A PRODUCTIVITY MASTER

▶ EFFORTLESS OPERATION FOR PRECISE WORK

Bobcat's dependable 1-2-tonne Mini Excavator range gives you the tools to get the job done. It combines the best digging performance and breakout forces with smooth and quick movement, plus an excellent working range to boost your efficiency.

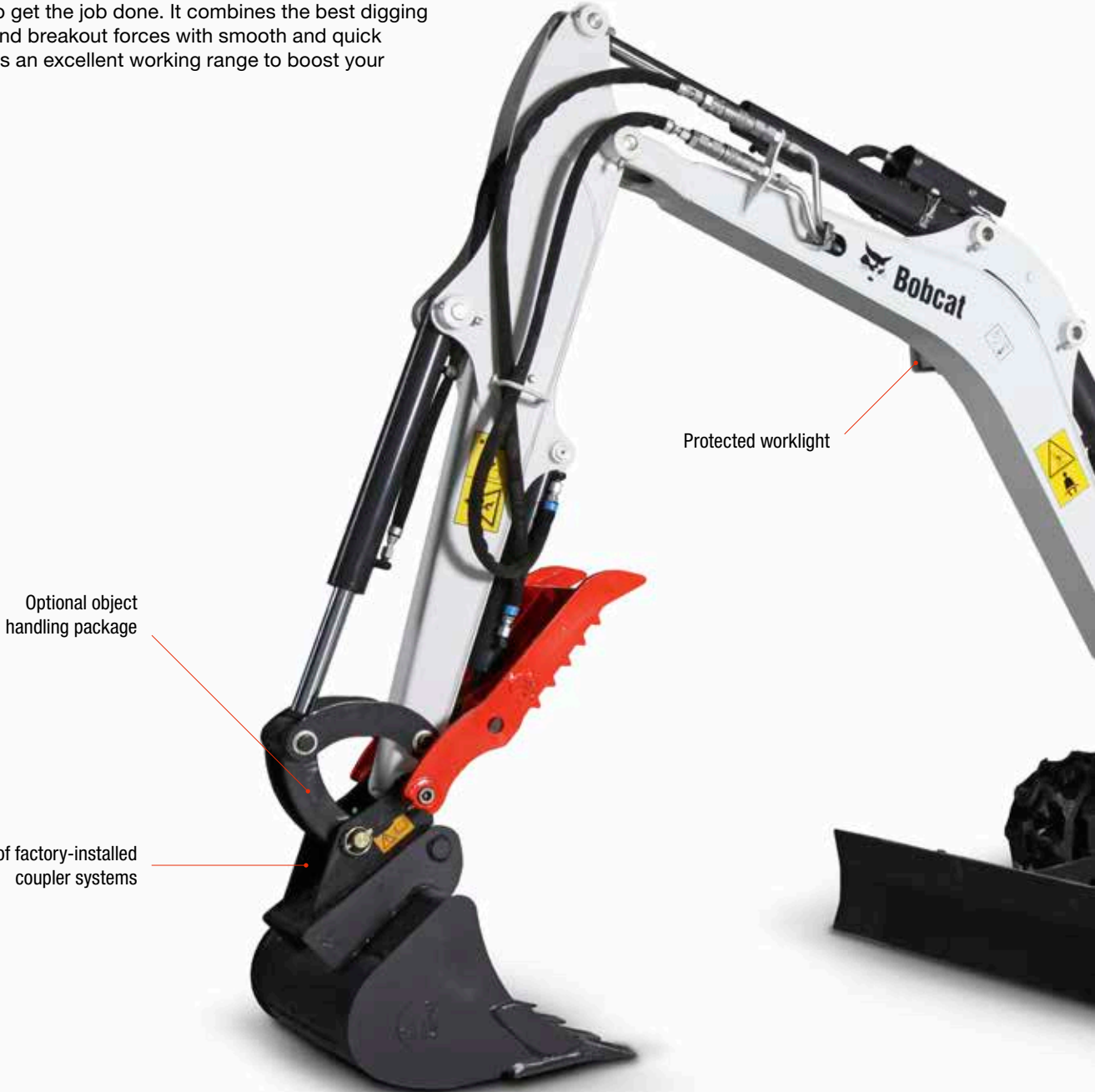

Optional object handling package

Protected worklight

Selection of factory-installed coupler systems



▶ INDUSTRY-LEADING VISIBILITY

Work safely day and night with a clear field of view, maximum visibility from inside the cab, and powerful LED lights.



▶ FIRST-CLASS COMFORT

Feel right at home in a roomy cab fully designed around your needs. The temperature and fan speed control keep you comfortable throughout the working day.



Optional LED light system
P. 15

TOPS/ROPS (FOPS Level 1 – for canopy only)
certified cab and canopy

Full control of your surroundings – thanks to the great visibility through larger glass area and excellent ergonomics
P. 8

Metal covers that open and close effortlessly for easy maintenance
P. 10

Mechanically controlled Stage V engine

Hydraulic oil level visible from outside

Upper-structure tie-downs for easy transportation

Autoshift 2-speed travel motors
P. 13

Easy-to-expand



▶ TRAVEL-FRIENDLY

Enjoy hassle-free transportation with a 2.5-tonne trailer. The automatic slew brake and upper structure tie-downs give you extra peace of mind when you need it.



▶ COMPACT BY DESIGN

Maneuver in tight spaces where other machines cannot. The retracted tracks and narrow frame are ideal for construction, renovation, utilities and landscaping.



PERFORMANCE



► EFFICIENT POWER

Bobcat's unique E17 and E17z / E19 / E20z hydraulic systems make the best possible use of the engine's power. Fast cycle times, combined with smooth control of class-leading breakout forces, provide maximum productivity. Boom and dipper stick cylinder cushioning – unique in their class – enhance overall smoothness.

► LIFT MORE, LIFT HIGHER

The superior dumping height makes loading trucks easy, while the reach at ground level means you don't need to reposition as often when digging. With enhanced stability and lifting capacity, combined with best-in-class proportional auxiliary flow, the Bobcat excavators offer you the highest versatility in operating a wide range of attachments.



POWER WHERE YOU NEED IT

► RIGHT TOOL FOR THE JOB

In backyards, urban areas and other tight job sites, a big machine means big challenges. Bobcat machines allow operators to work in constrained environments, in extreme proximity to walls and other challenging situations.

► PEACE OF MIND

Trust the machine in all situations. The Zero House Swing (ZHS) functionality provides 320° stability and flexibility of movement when working close to obstacles. Minimize the risk of potential damage while maximizing productivity.

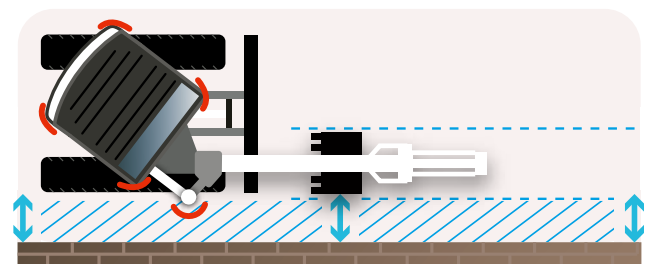

Conventional tail swing

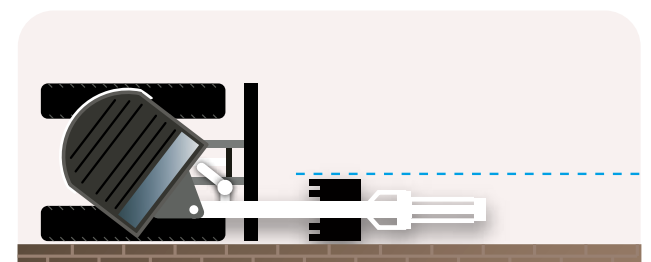

Zero House Swing (ZHS)

STEP INSIDE



▸ PRECISION MEETS PRACTICALITY

Step into the cab and immediately get to grips with the intuitive controls – ideal for both experienced and novice operators. Joysticks with all key functions in the right place; smooth travel pedals; and personalized controls for pinpoint accuracy.





BUILT TOUGH

► TOUGH MATERIALS

Using highly durable materials makes the Bobcat excavators hard-wearing and robust.

- Rear tailgates protected by casted counterweights
- Oversized cylinders for long life
- New paint and surface treatment process
- Reinforced expandable undercarriage to enhance rigidity
- Cylinder covers for heavy applications

► TESTED DESIGN

The design features are tested under extreme conditions and ensure extra durability and peace of mind while working.

- Metal covers can be opened or bolted on
- 2-piece blade cylinder hoses
- Wrenchless hydraulic hose technology helps prevent leakage
- Proven boom and dipper stick design
- Top-mounted boom cylinder



Easy access to all vital components



► MACHINE IQ

BOBCAT® Machine IQ Wireless Communications enhances the support for your Bobcat machine.

- Durable built-in monitoring electronics
- Data is available to our machine monitoring specialist
- Maintenance is optimized for your business
- Data-driven services maximize uptime

► STANDARD WARRANTY

Bobcat Company develops every machine to the highest standards of quality and durability. That's why our standard warranty provides 24 months or 2000 operating hours (whichever occurs first) of coverage.

THERE'S NO TIME FOR DOWNTIME. STAND UP TO THE HARSHTEST CONDITIONS. DAY AFTER DAY.



Changing filters



► PROTECTION PLUS EXTENDED WARRANTY

Enjoy total peace of mind with a Protection Plus® extended warranty. Providing the same level of protection as the standard warranty, Protection Plus also reflects different customer needs and expectations by offering a choice of durations and annual operating hours. According to your needs, you can benefit from the coverage for up to 5 years or 6000 engine hours. And Protection Plus is transferrable – so it will likely increase your machine's resale value.



► BOBCARE

A long-running machine starts with proper planned maintenance. Which protects against repair costs and unplanned failures when you're counting on your machine to work.

- Avoid risk by preventing major repairs and complete failures.
- Accomplish more by reducing downtime and increasing your productivity and profitability.



Casted counterweight protects the tailgate

CHOOSE YOUR ANIMAL

E17

▶ CONVENTIONAL TAIL SWING

Entry level “1.5 ton” excavator – designed for easy transportability.

- Transport weight below 1.6 tons



E17z

▶ ZERO HOUSE SWING

For operators looking for compactness and easy transportability.

- Transport weight close to 1.6 tons



E19

► CONVENTIONAL TAIL SWING

For experienced operators focusing on performance and operator comfort.

- Additional counterweight for excellent stability
- Joystick-controlled boom swing and auxiliary for greater comfort and accuracy with selectable auxiliary modes
- Autoshift travel motors to guarantee better traction and manoeuvrability



E20z

► ZERO HOUSE SWING

For operators looking for compactness without sacrificing operator comfort and performance.

- Zero House Swing functionality (even with cab)
- Stability of best-in-class conventional machine
- Joystick-controlled boom swing and auxiliary for greater comfort and accuracy with selectable auxiliary modes
- Autoshift travel motors to guarantee better traction and manoeuvrability

STANDARD EQUIPMENT & OPTIONS

STANDARD EQUIPMENT & OPTIONS				
	E17	E17z	E19	E20z
PERFORMANCE				
2nd auxiliary hydraulics	–	–	•	•
980 mm dozer blade with two 190 mm blade extensions	✓	✓	✓	✓
Additional counterweight for excellent stability	–	–	•	–
Auxiliary hydraulic line on dipperstick	•	•	•	•
Auxiliary quick couplers	•	•	✓	✓
Double acting auxiliary hydraulics	✓	✓	✓	✓
Hydraulic clamp	–	–	•	•
Hydraulic joystick controls	✓	✓	✓	✓
Long dipperstick with clamp eyes	–	–	•	•
Long dozer blade	•	•	•	•
Object handling device (safety valves + overload warning device + lifteye)	•	•	•	•
Proportional and adjustable (3 modes) fingertip auxiliary hydraulic control	–	–	•	•
Proportional fingertip boom swing offset hydraulic control	–	–	•	•
Special applications kit	•	•	•	•
CAB & CANOPY				
AM/FM MP3 stereo radio	•	–	•	•
Beacon	•	•	•	•
Cupholders	✓	✓	✓	✓
Deluxe textile suspension seat (cab)	•	–	•	•
Fire extinguisher	•	•	•	•
Foldable & ergonomic pedals	✓	✓	✓	✓
Horn	✓	✓	✓	✓
Keyless ignition	•	•	•	•
Mirrors	•	•	•	•
Retractable seat belt	✓	✓	✓	✓
Storage compartment	✓	–	✓	–
TOPS/ROPS cab with heater	•	–	•	•
TOPS/ROPS/FOPS* canopy	✓	✓	✓	✓

✓ = standard • = option – = not available

STANDARD EQUIPMENT & OPTIONS				
	E17	E17z	E19	E20z
LIGHTS & BEACON				
Additional front lights and a rear light	•	•	•	•
LED lights set	–	–	•	•
Work light	✓	✓	✓	✓
MISCELLANEOUS				
Battery disconnect switch	✓	✓	✓	✓
Boom load holding valve	•	•	•	•
Boom, arm, bucket cylinder covers	•	•	•	•
Control console locks	✓	✓	✓	✓
Engine monitor with auto shutdown	✓	✓	✓	✓
Full fuel warning alarm	✓	✓	✓	✓
Grease gun set	•	–	•	–
HD travel hoses guard	•	•	•	•
Hydraulic and travel control lockouts	✓	✓	✓	✓
Hydraulically retractable undercarriage from 1360 to 980 mm	✓	✓	✓	✓
Upperstructure 4 point tie down	✓	✓	✓	✓
Warranty: 24 months or 2000 hours (whichever occurs first)	✓	✓	✓	✓
Water separator	✓	✓	✓	✓
TRACKS & TRAVEL				
230 mm rubber track	✓	✓	✓	✓
Auto shift drive motors	–	–	•	•
Travel motion alarm	•	•	•	•
2-speed travel	•	✓	✓	✓

* Tip Over Protective Structure (TOPS) – Meets requirements of ISO 12117.
 Roll Over Protective Structure (ROPS) – Meets requirements of ISO 3471.
 Falling Object Protective Structure (FOPS) – Meets requirements of ISO 3449.

► PERSONALIZE YOUR MACHINE

Sometimes, we all want to add a specific functionality or a personal touch to the machine. Choose from a list of comprehensive options and customize your mini excavator to your heart's content!



TOPS/ROPS cab with heater



Fire extinguisher



LED lights



AM/FM stereo radio

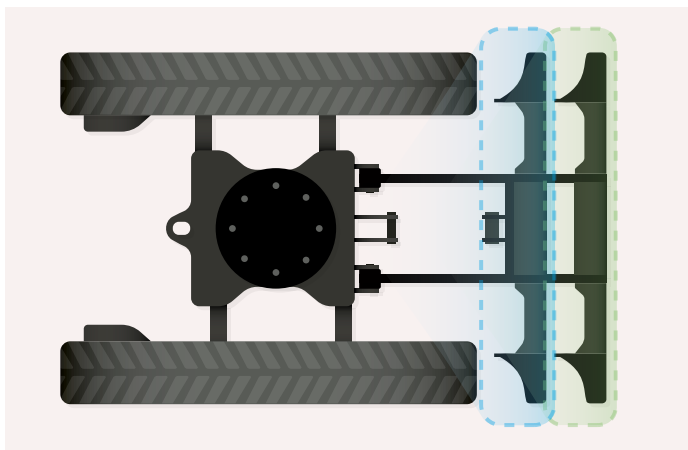

► DOZER BLADE OPTIONS

- Standard length for customers that prefer compactness for working in reduced spaces.
- Extended length for customers that prefer dustpanability and increased front stability.

All blades provide excellent departure angles and higher profile for better dozing performance.

MULTI-TOOL CARRIER

► FIT FOR EVERYTHING

The wide range of attachments lets you adapt to any job in any environment. The hydraulic clamp and convenient design let you connect in seconds and prepare for any project that lies ahead.

- Augers
- Breakers
- Digging buckets
- Flail mower
- Grading buckets
- Hydraulic clamps
- Klac coupler
- Laser equipment
- Mechanical German type coupler (MS01)
- Mechanical German type coupler (MS01) with tilt function
- Mechanical pin grabber coupler
- Skeleton buckets
- Tilt buckets



Augers



Hydraulic clamps



Grading buckets



Tilt buckets



Breaker

SPECIFICATIONS

SPECIFICATIONS				
	E17	E17z	E19	E20z
WEIGHTS				
Operating weight with canopy and bucket (ISO 6016)	1 711 kg	1 749 kg	–	–
Operating weight with cab and bucket (ISO 6016)	–	–	1 885 kg	2 019 kg
Transport mass (no attachment)	1 594 kg	1 632 kg	1 768 kg	1 902 kg
Weight reduction with canopy	–	–	-96 kg	-81 kg
Additional weight for cab with heating	96 kg	–	–	–
Additional weight for counterweight	–	–	41 kg	–
Additional weight for long dipperstick	–	–	6 kg	6 kg
Additional weight for long dozer blade	–	9 kg	–	9 kg
Ground pressure with rubber tracks	29.4 kPa	30.06 kPa	32.4 kPa	31.1 kPa
ENGINE				
Make / model	Yanmar / 3TNV74F-SPBC (Stage V)			
Fuel	Diesel			
Number of cylinders	3			
Displacement	993 cm ³			
Maximum power @ 2400 RPM (ISO 14396)	11 kW			
Maximum torque @ 1800 RPM (SAE J1995)	50.2 Nm			
HYDRAULIC SYSTEM				
Pump type	Triple gear pump	Dual piston pump with gear pump		
Total hydraulic capacity	–	41.3 l/min	–	41.3 l/min
Piston pump capacity	–	–	30.0 l/min	–
Gear pump capacity	32.5 l/min	–	41.3 l/min	–
Auxiliary flow (AUX1)	32.5 l/min	–	30 l/min	–
Auxiliary relief (AUX1)	227 bar	–	180 bar	–
Auxiliary flow (AUX2)	–	–	–	15 l/min
Auxiliary relief (AUX2)	–	–	–	179 bar
PERFORMANCE				
Digging force, dipperstick (ISO 6015)	9 108 N		10 371 N	
Digging force, long dipperstick (ISO 6015)	–	–	9 279 N	
Digging force, bucket (ISO 6015)	16 177 N		20 835 N	
Drawbar pull	14 334 N	19 302 N	19 380 N	19 302 N
Travel speed, low range	2.1 km/h	2.7 km/h		2.1 km/h
Travel speed, high range	4.3 km/h		4.2 km/h	
SLEW SYSTEM				
Boom swing, left	80°			
Boom swing, right	60°			
Slew rate	8.7 RPM	10.1 RPM	8.4 RPM	
FLUID CAPACITIES				
Fuel reservoir	19 l			
Hydraulic reservoir	13.9 l			
ENVIRONMENTAL				
Noise level LpA (EU Directive 2006/42/EC)	79 dB(A)	81 dB(A)	79 dB(A)	82 dB(A)
Noise level LWA (EU Directive 2000/14/EC)	93 dB(A)			
Whole body vibration (ISO 2631–1)	0.33 ms ⁻²	0.91 ms ⁻²	0.91 ms ⁻²	0.49 ms ⁻²
Hand-arm vibration (ISO 5349–1)	0.51 ms ⁻²	1.78 ms ⁻²	1.78 ms ⁻²	1.32 ms ⁻²

Certain specifications are based on engineering calculations and are not actual measurements. Specification(s) are provided for comparison purposes only and are subject to change without notice. Specification(s) for your individual Bobcat equipment will vary based on normal variations in design, manufacturing, operating conditions, and other factors. Pictures of Bobcat units may show other than standard equipment.

DIMENSIONS & WORKING AREA

WORKING AREA

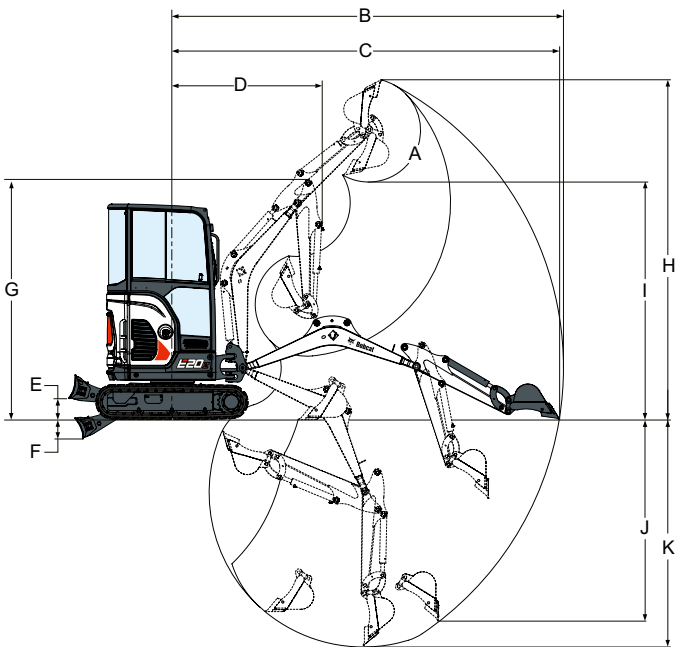

WORKING AREA				
	E17	E17z	E19	E20z
A	196°			
B	3 919	3 971	4 084	4 134
B*	–	–	4 257	4 307
C	3 871	3 923	4 039	4 089
C*	–	–	4 214	4 264
D	1 526	1 560	1 542	1 592
D*	–	–	1 561	1 611
E	220			
E*	300	300	300	300
F	204			
F*	254	254	254	254
G	2 405	2 406	2 564	
H	3 371	3 378	3 573	
H*	–	–	3 701	
I	2 370	2 369	2 566	
I*	–	–	2 693	
J	1 810	–	1 948	
J*	–	–	2 115	
K	2 249	–	2 385	
K*	–	–	2565	

DIMENSIONS

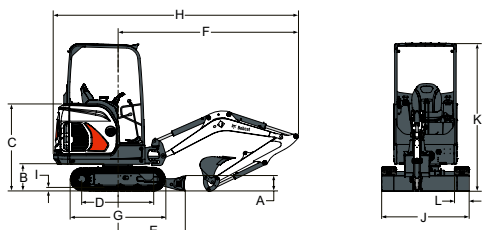

E17, E19

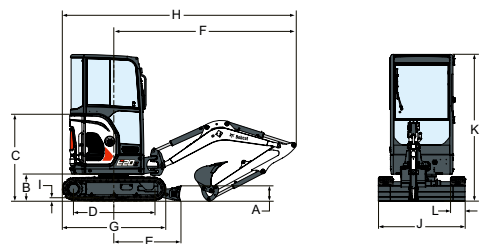
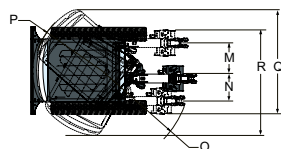

E17z, E20z

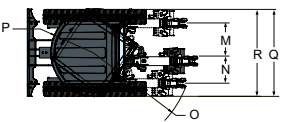

DIMENSIONS				
	E17	E17z	E19	E20z
A	235			
B	419			
C	1 340	1 138	1 340	1 138
D	1 114			1 258
E	1 045			
F	2 666	2 715	2 832	2 882
G	1 476			1 620
H	3 665	3 450	3 831	3 688
H*	–	–	3 812	3 669
I	25			
J	980			
J*	1 360			
K	2 299	2 297	2 299	2 297
L	230			
M	433	450	433	476
N	589	638	589	638
O	1 128	1 190	1 154	1 190
P	1 009	690	1 009	690
Q	1 801	1 532	1 801	1 532
R	1 645	1 370	1 645	1 370

Values marked with * – Long dipperstick
Unit: mm

FINANCING OPTIONS

24, 36, OR 48 MONTH FINANCING*

Take advantage of 24, 36 or 48 month financing programs starting from **0% interest** and improve your cash flow. Ask your dealer for the financing offers available.

100 MACHINES / 150 ATTACHMENT FAMILIES / 1 TOUGH ANIMAL



**SKID STEER
LOADERS**



**COMPACT TRACK
LOADERS**

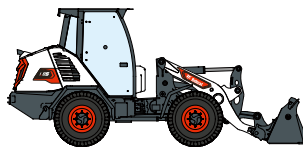

**COMPACT WHEEL
LOADERS**



**SMALL ARTICULATED
LOADERS**

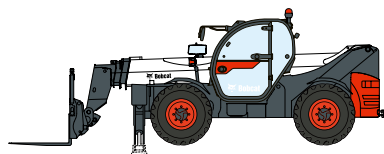

TELEHANDLERS

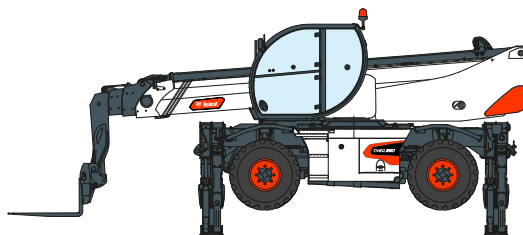

ROTARY TELEHANDLERS



**LIGHT COMPACTION
EQUIPMENT**



**MINI TRACK
LOADER**



COMPACT EXCAVATORS

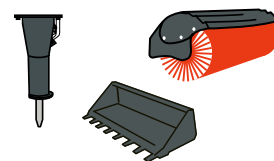

ATTACHMENTS

DOOSAN

www.bobcat.com

Bobcat is a Doosan Company. Doosan is a global leader in construction equipment, power & water solutions, engines, and engineering proudly serving customers and communities for more than a century. | Bobcat and the Bobcat logo are registered trademarks of Bobcat Company in the United States and various other countries. ©2022 Bobcat Company. All Rights Reserved.

©2022 BOBCAT B4500151-EN (08-22)



Bobcat®

*Financing options may vary by country and dealer. Always ask your dealer about currently available financing options. Terms and conditions may apply.

Doosan Bobcat EMEA, U Kodelky 1810, 263 12 Dobříš, Czech Republic